

V1 ESC 1:100

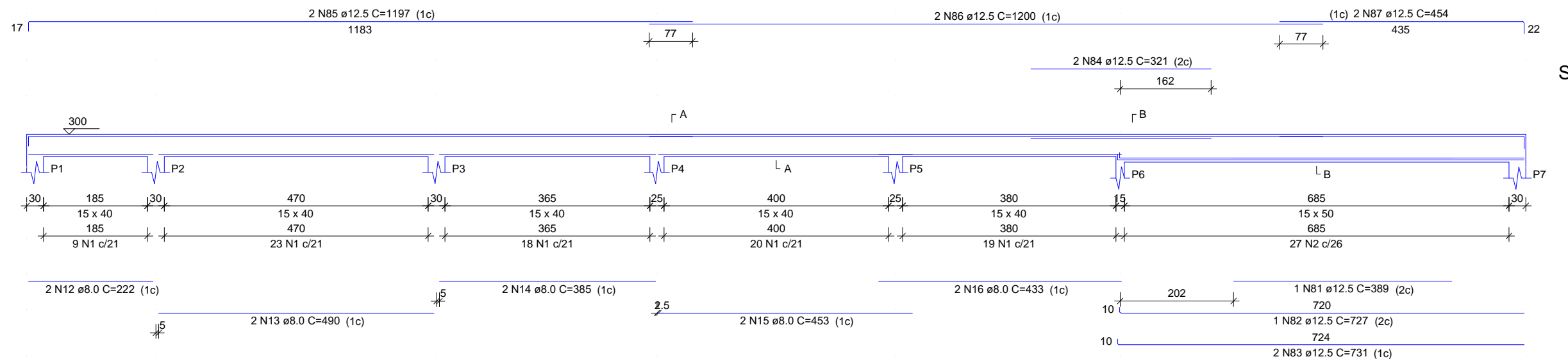

V2 ESC 1:100

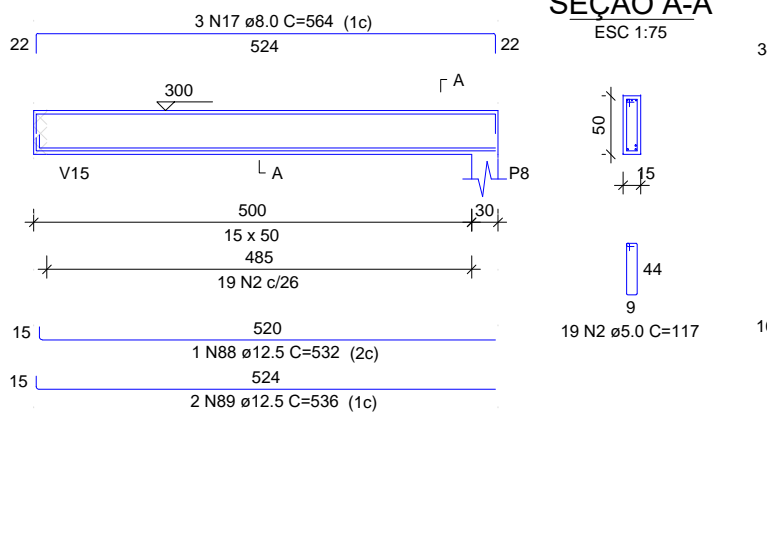

V3 ESC 1:100

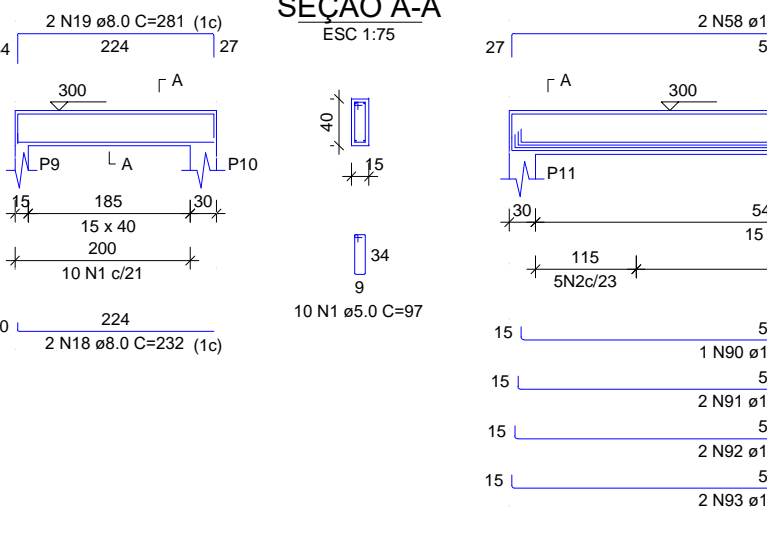

V4 ESC 1:100

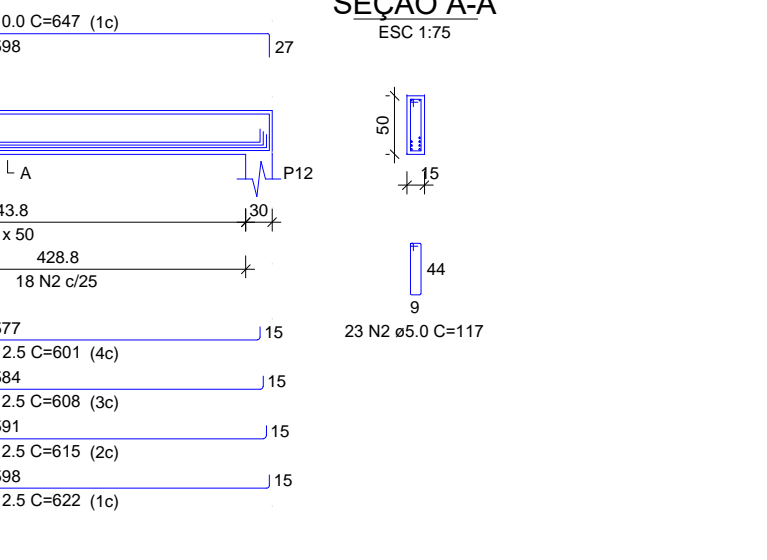

V5 ESC 1:100

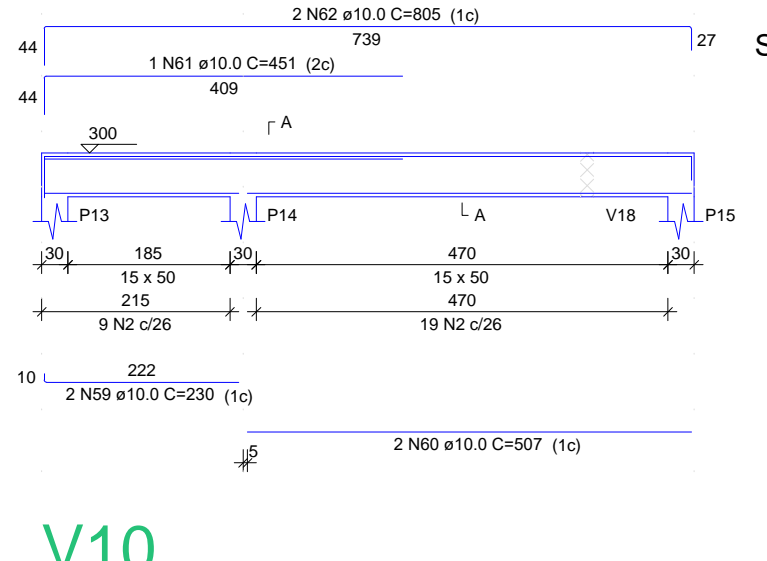

V6 ESC 1:100

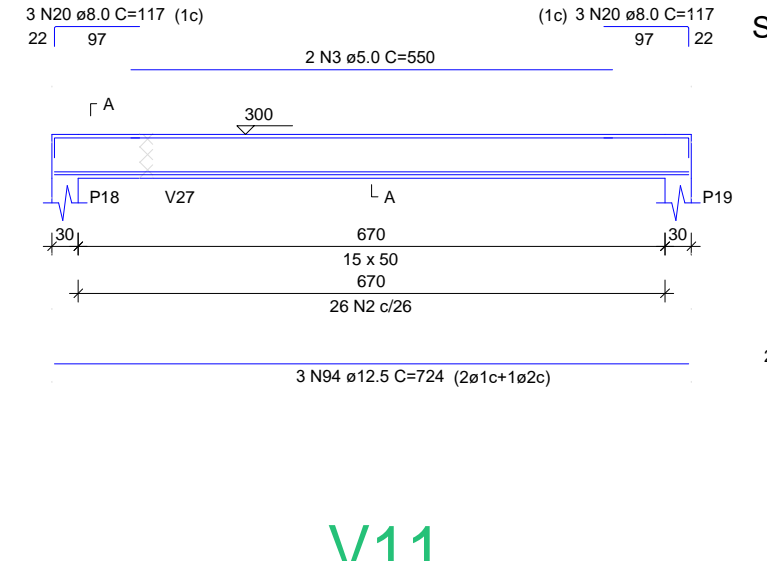

V7 ESC 1:100

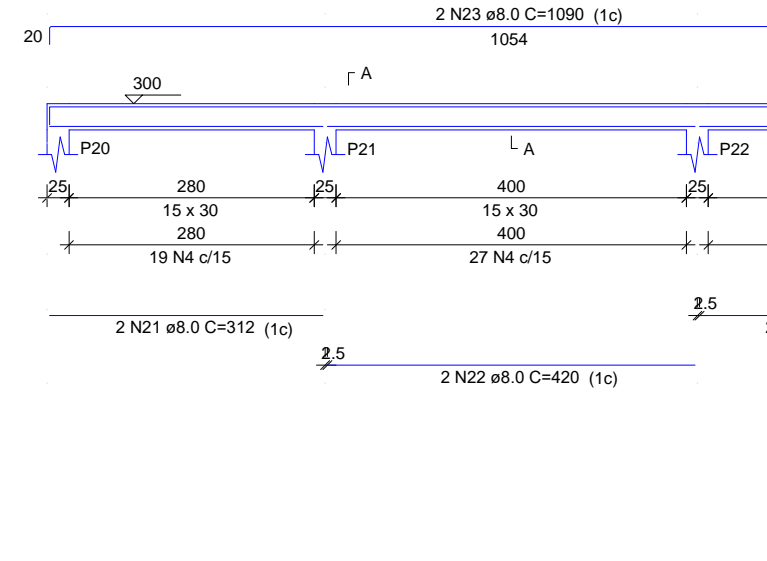

V8 ESC 1:100

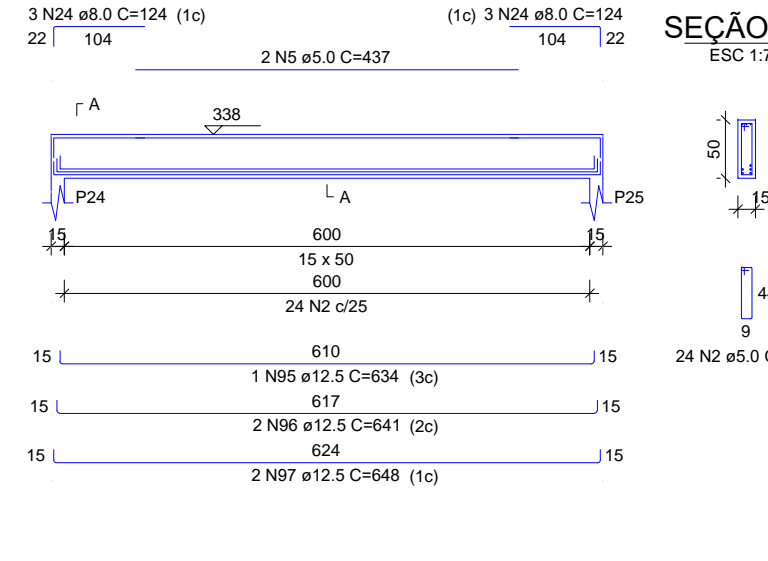

V9 ESC 1:100

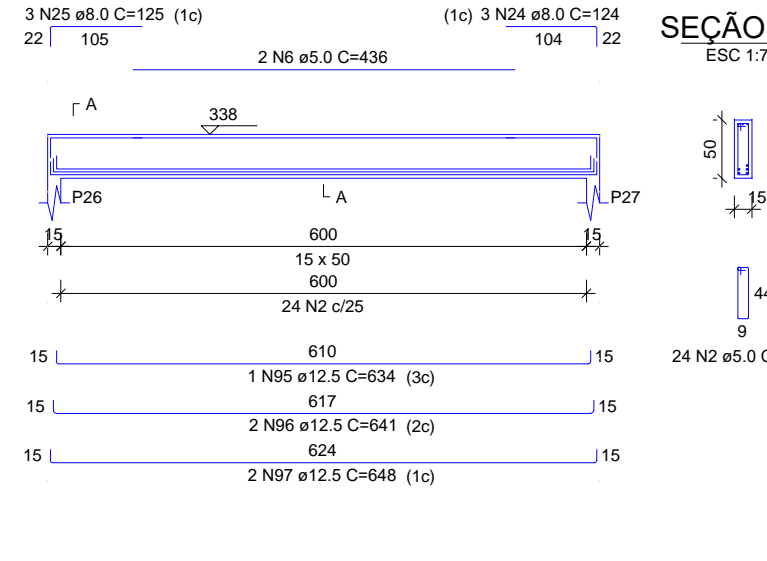

V10 ESC 1:100

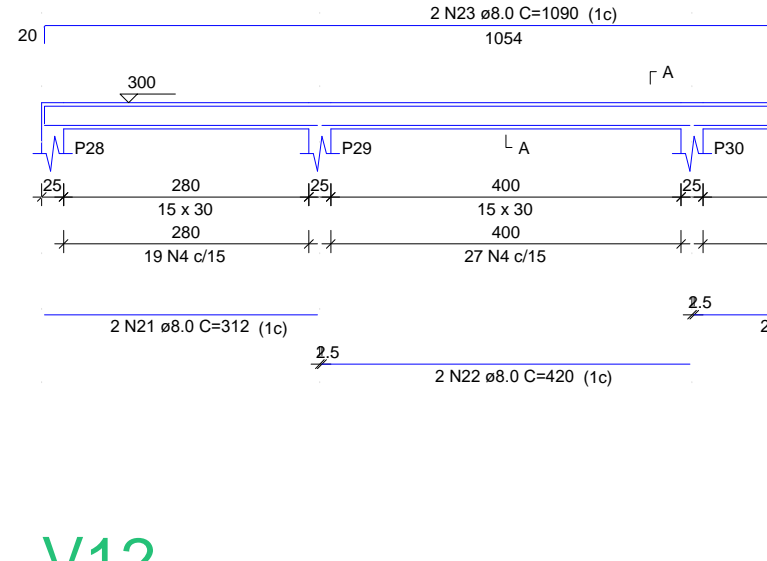

V11 ESC 1:100

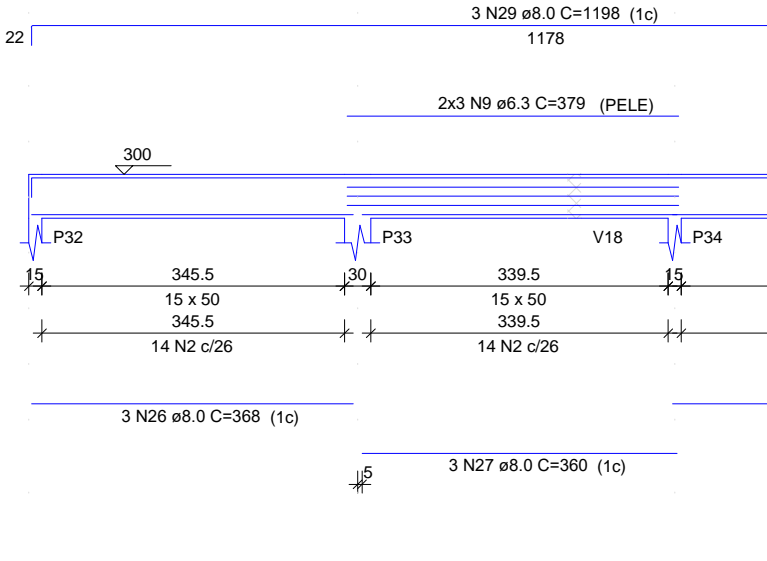

V12 ESC 1:100

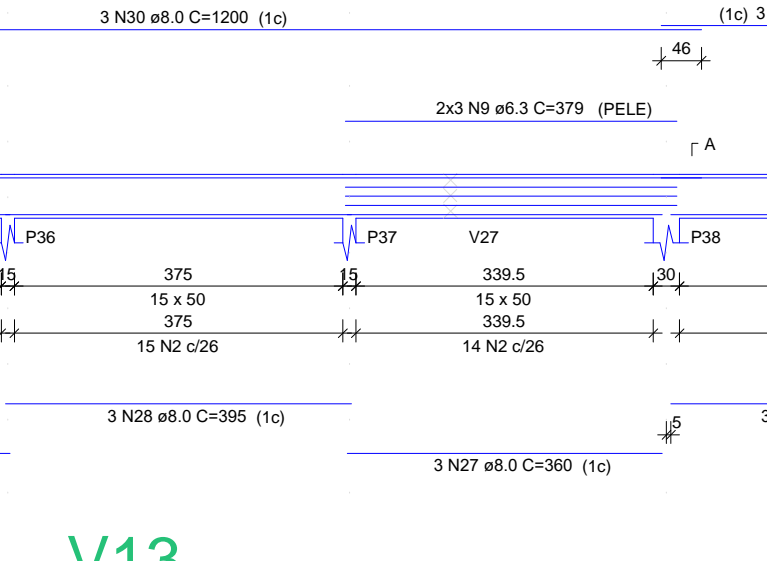

V13 ESC 1:100

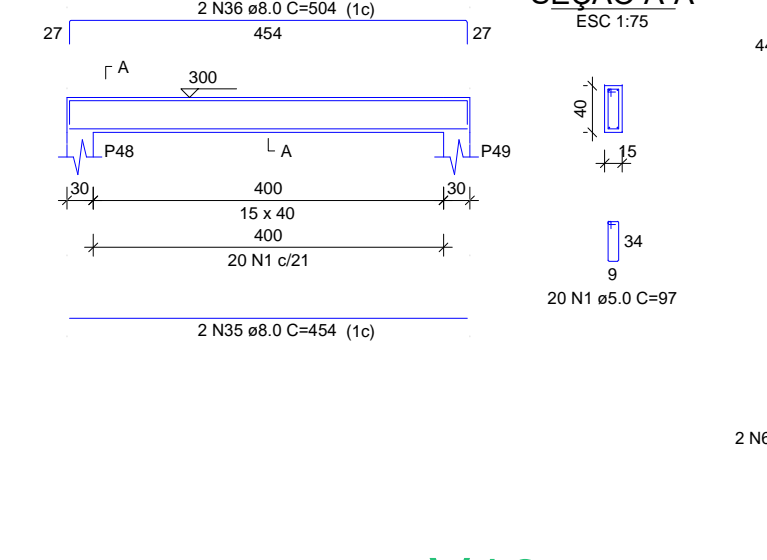

V14 ESC 1:100

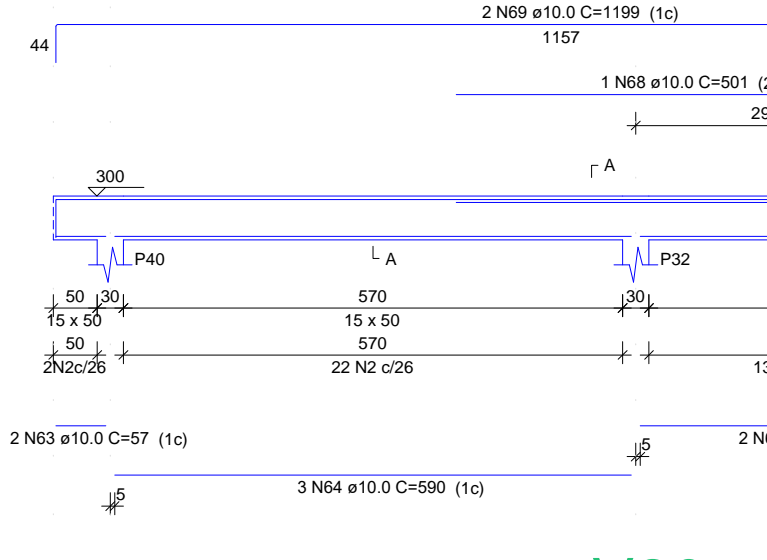

V15 ESC 1:100

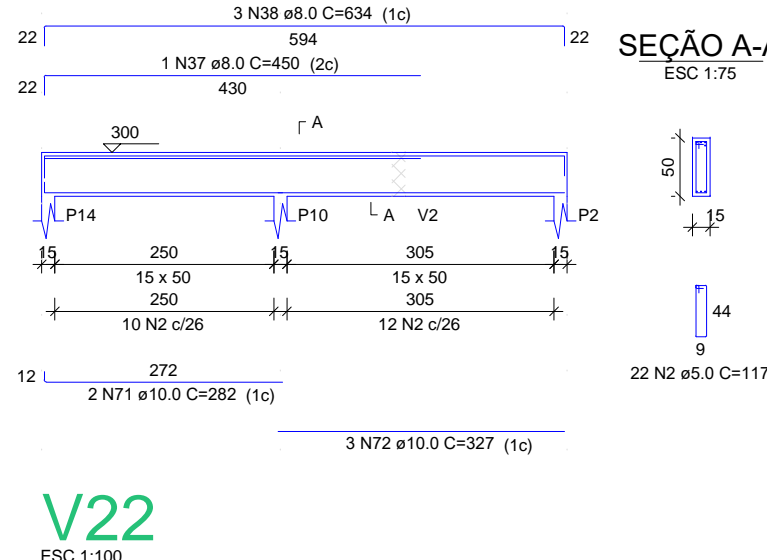

V16 ESC 1:100

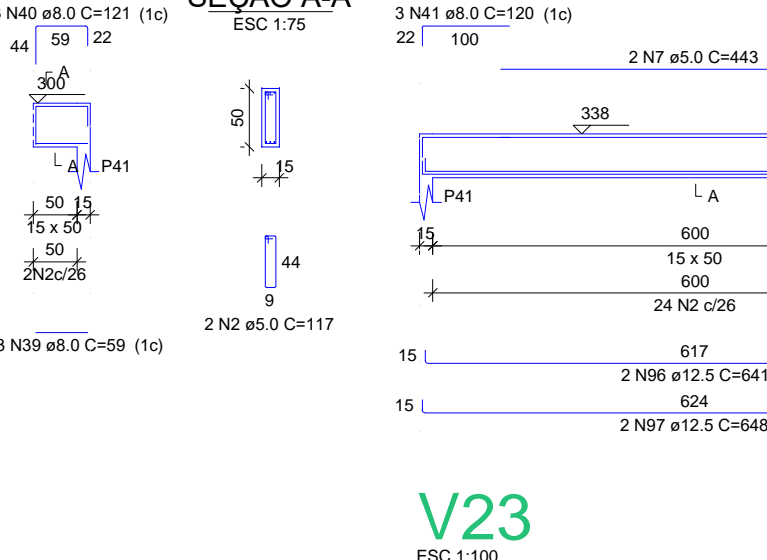

V17 ESC 1:100

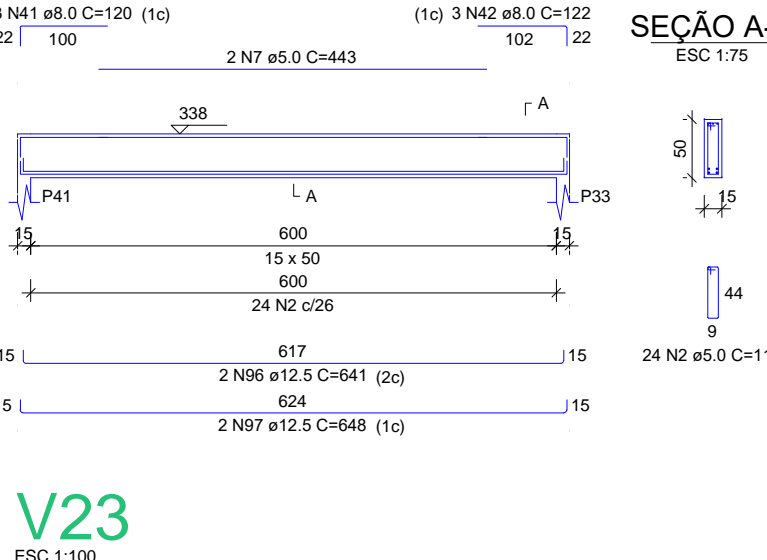

V18 ESC 1:100

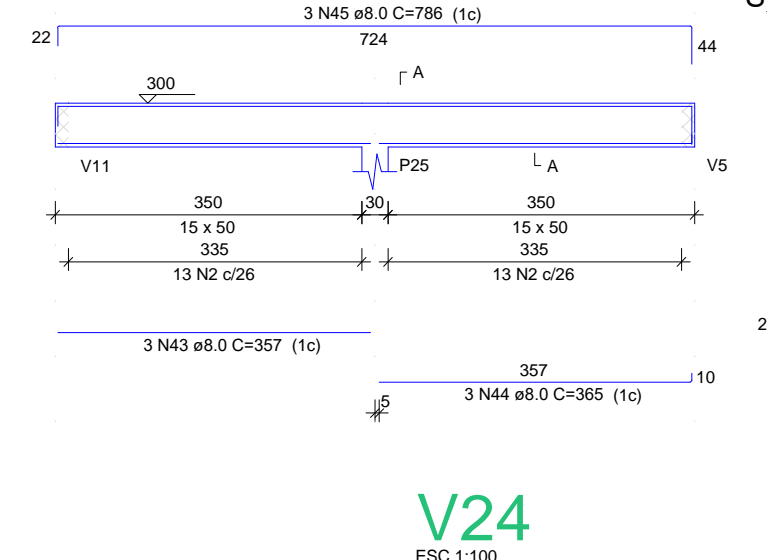

V19 ESC 1:100

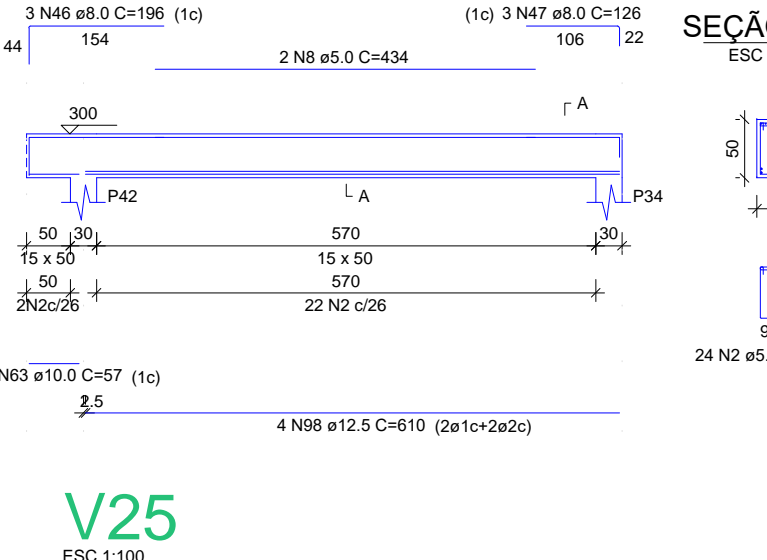

V20 ESC 1:100

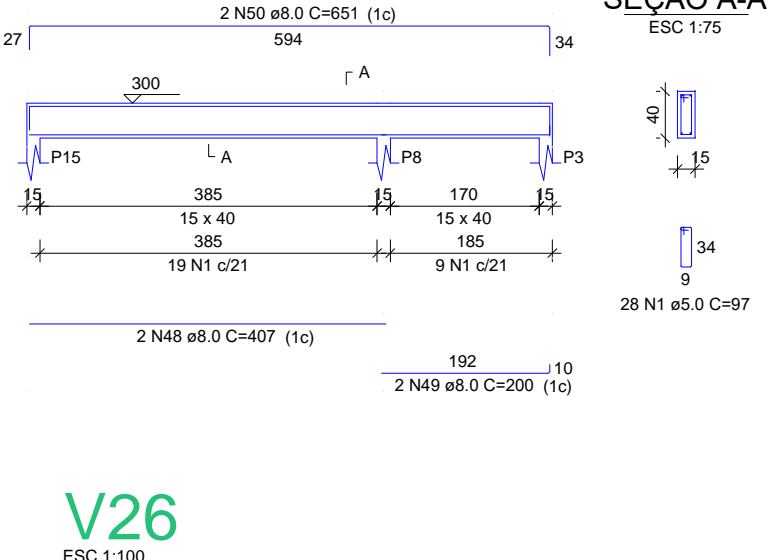

V21 ESC 1:100

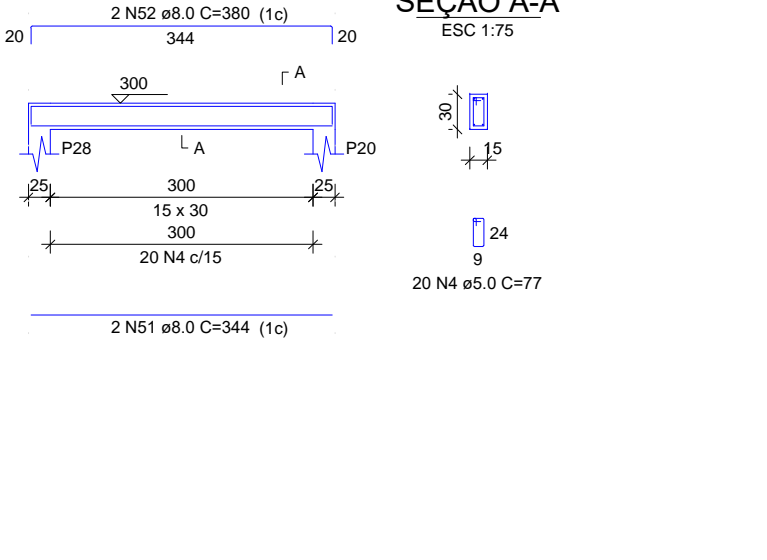

V22 ESC 1:100

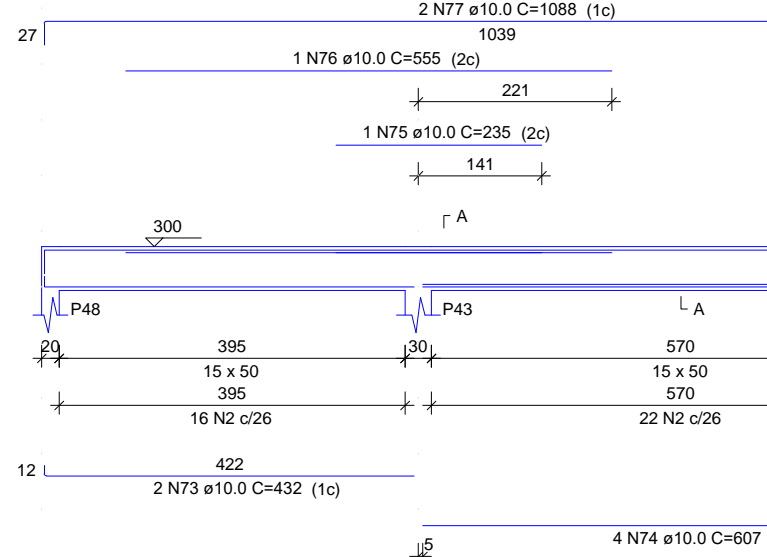

V23 ESC 1:100

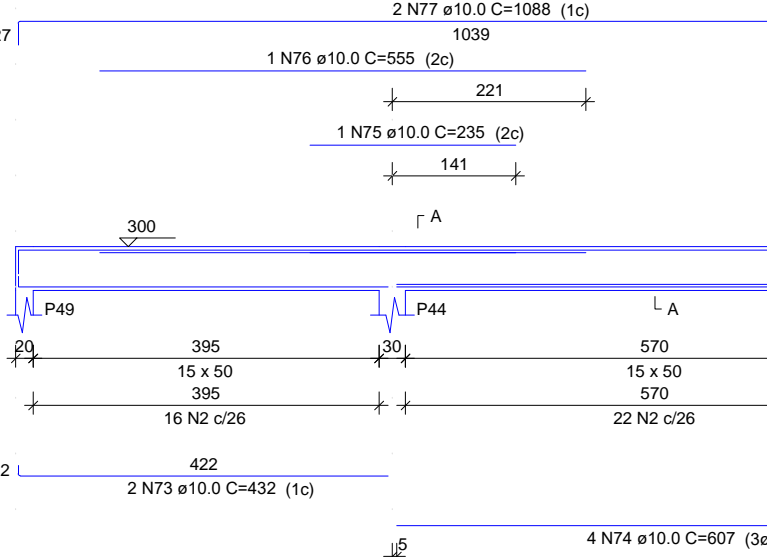

V24 ESC 1:100

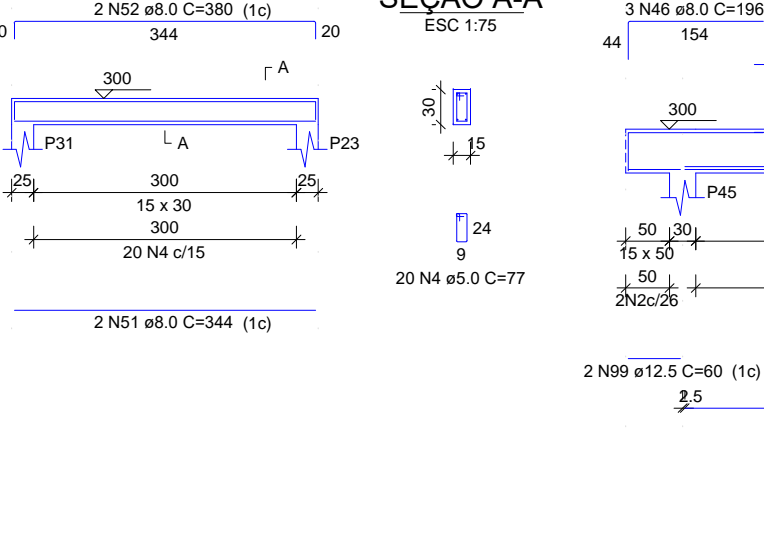

V25 ESC 1:100

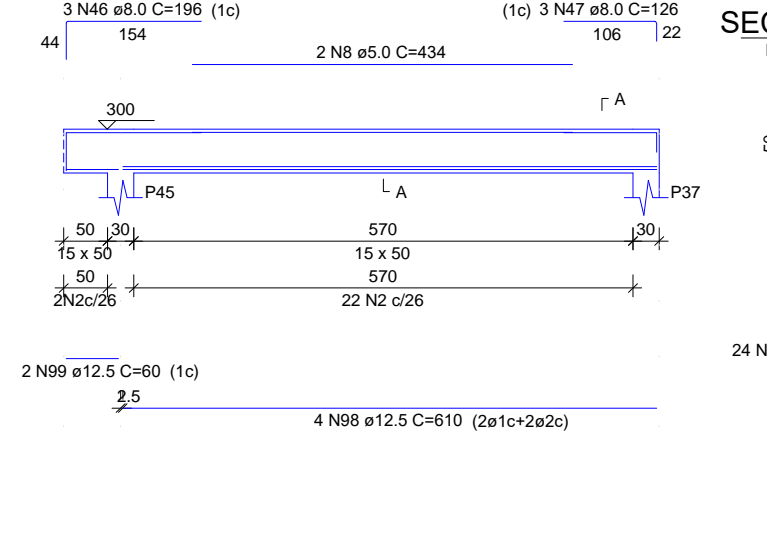

V26 ESC 1:100

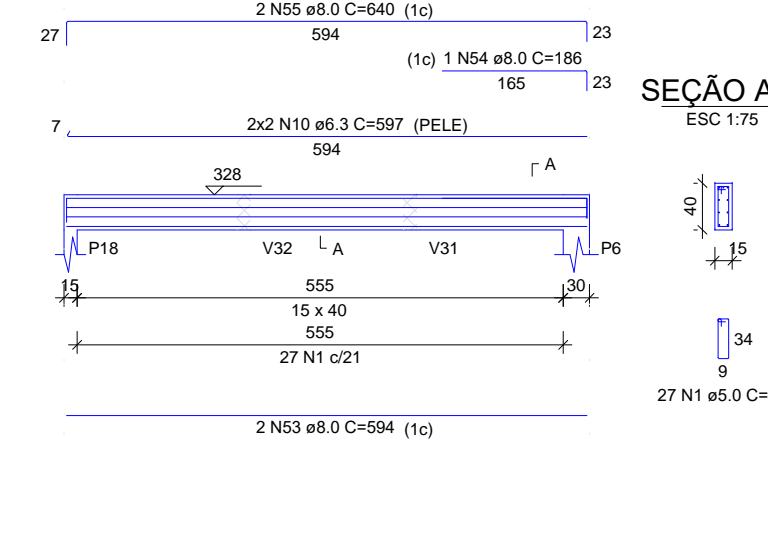

V27 ESC 1:100

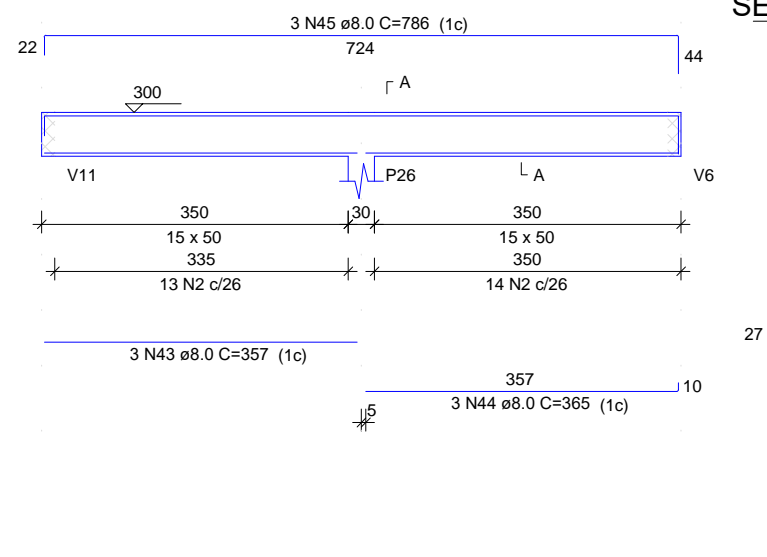

V28 ESC 1:100

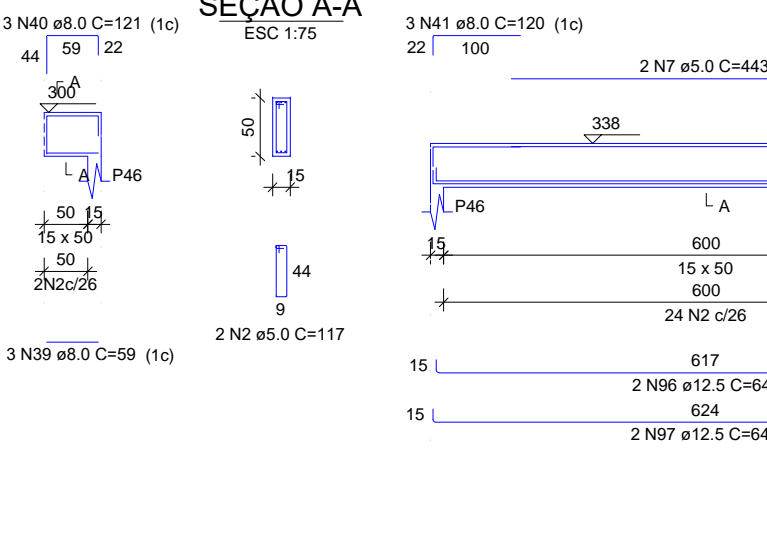

V29 ESC 1:100

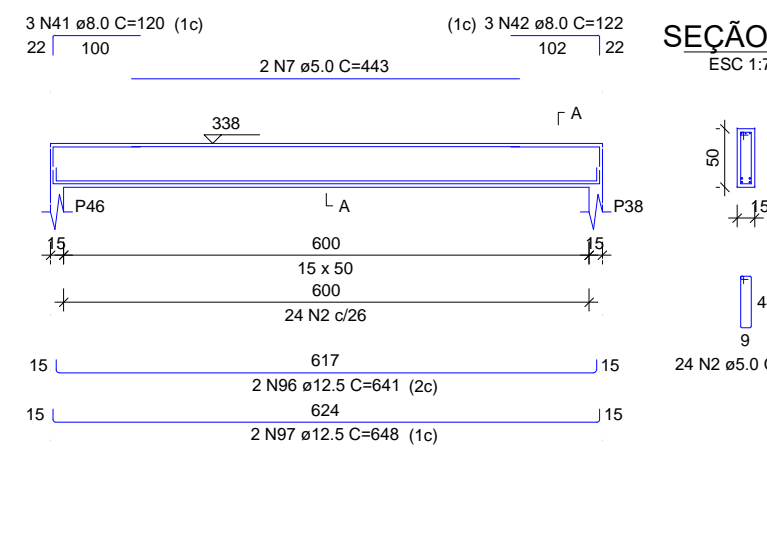

V30 ESC 1:100

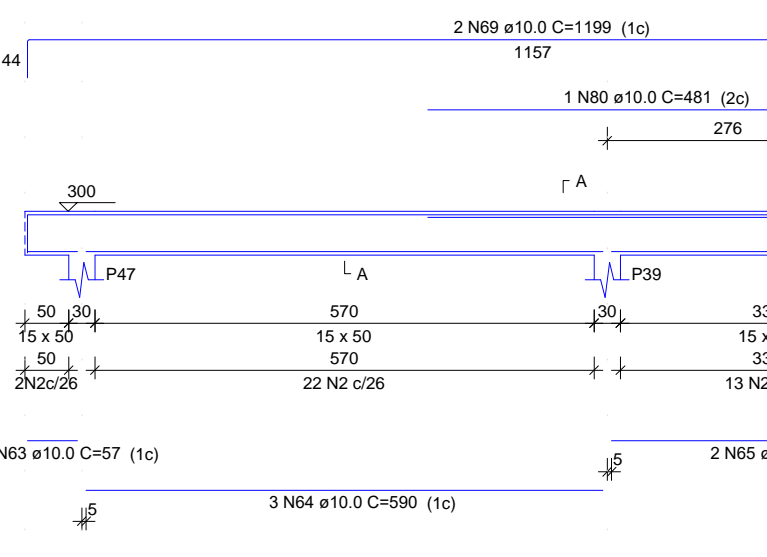

V31 ESC 1:100

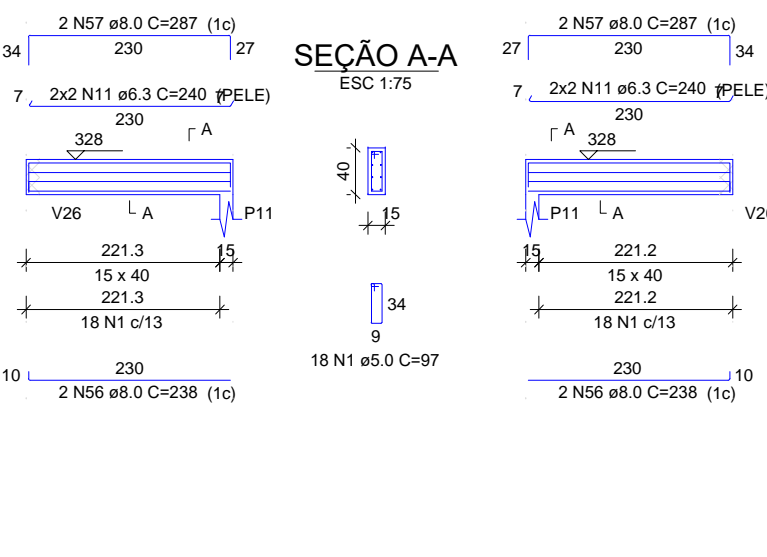

V32 ESC 1:100

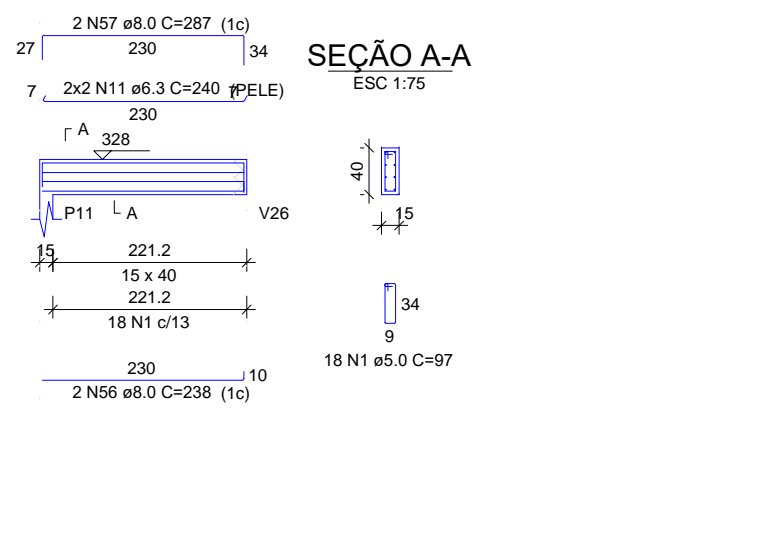

RELAÇÃO DO AÇO

Table with columns: AÇO, N, DIAM (mm), QUANT, C.UNIT (cm), C.TOTAL (cm). Lists steel reinforcement details for various beams.

RESUMO DO AÇO

Summary table with columns: AÇO, DIAM (mm), C.TOTAL (cm), PESO ± 10% (kg). Provides total steel weight and volume.

Color and finish table with columns: COR, ESP.PENNA. Lists color codes for different finishes.



Project information form including fields for PROPRIETÁRIO, CÁLCULO, CONSTRUÇÃO, and approval stamps for REVISÃO, PROJETO, CLIENTE, LOCAL, CONTEÚDO, ESCALA, and DATA.



AV. PREFEITO GILDO OTTEIRO, S/N CENTRO - MARCO - CE 14700-000 BR 364-A, 1213 E 11 3642-1115 www.marco.ce.gov.br CNPJ: 07.546.516/0001-47

05/06